

VW M3-02.

LSC directional control valves  
in monoblock design.

Linde Hydraulics

*Linde*

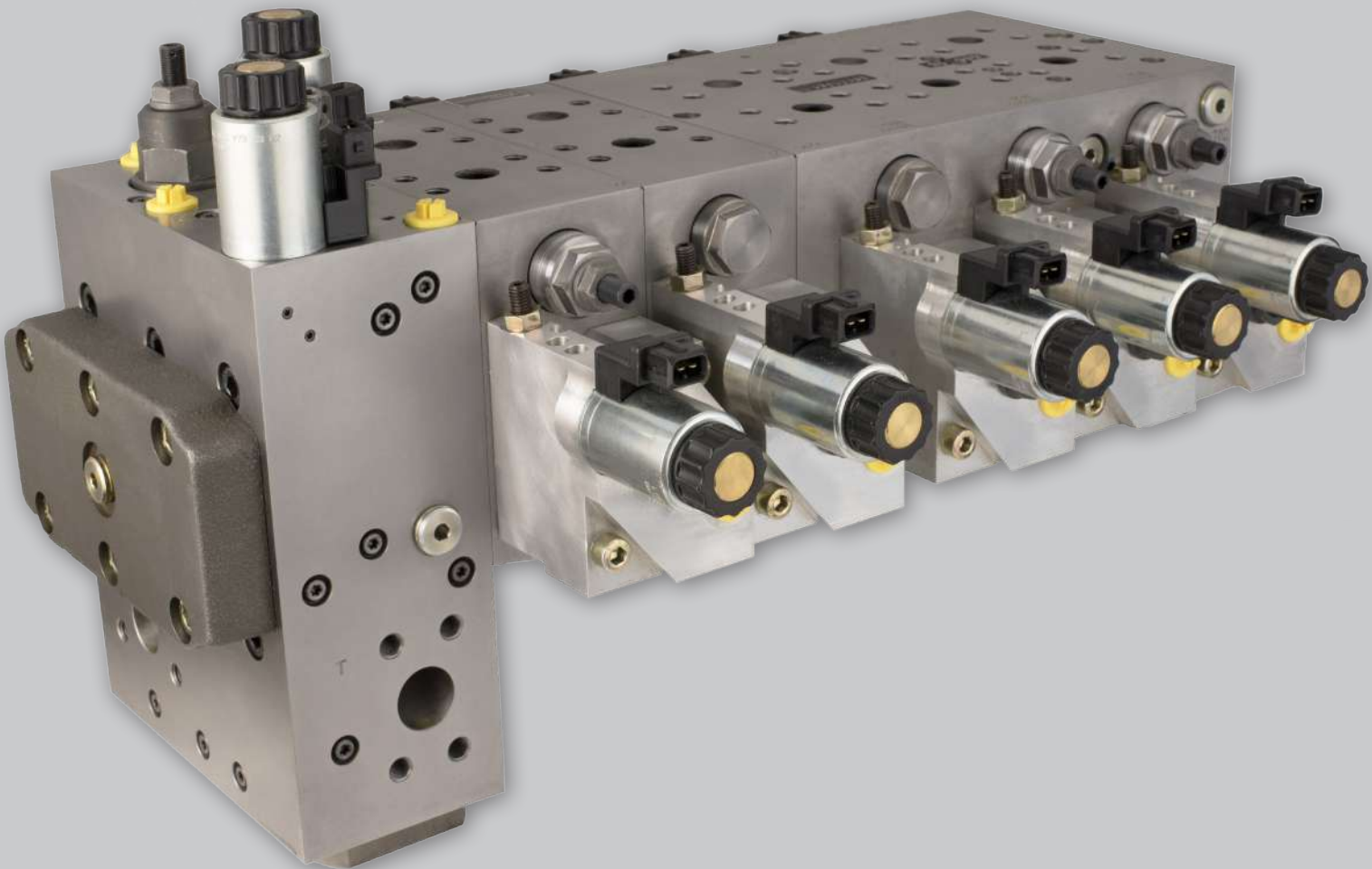

## LSC - Linde Synchron Control. The LS system with proportional flow distribution.

Linde Synchron Control (LSC) is a valve technology system for open high-pressure hydraulic circuits. It is a load-sensing (LS) system that consistently guarantees identical machine responses in terms of sensitivity and speed when the operator's input is the same. It does this independent of the load involved, and even when there are multiple actuators of different pressure levels.

It stands out from other LS systems thanks to its pressure compensators, which are logically set downstream and enable proportional flow distribution. If the volume required by all actuators exceeds the delivery rate of the installed pump(s), no actuator will suddenly stop. Instead, all actuators will be reduced accordingly and the installed power will be utilized in an optimal way.

Machines with LSC are therefore intuitive to operate while enabling reproducible workflows and guaranteeing excellent handling performance.

It is also highly efficient: The demand-based pressure and volume flow regulation ensures that the prime mover only has to provide precisely as much power as the task requires. This saves energy, particularly in partial-load operational range. Closed center valves only open once the pump pressure has reached the load pressure level, preventing any lowering of the load in idle mode and at the

beginning of the movement. In addition, no recirculation volumes are required when the machine is idle and the pump can be set to a minimum level. This means that there is practically no loss of power. The system therefore saves a substantial amount of fuel, particularly in comparison to systems with circulation pressure compensator and open center designs.

The LSC features parallel system architecture. This means that additional actuators (and therefore additional directional control valve sections) can be easily integrated into the system without altering the existing components or resetting the machine. Multiple-circuit systems are also possible.

The system and its components are therefore basically the same for every sort of machine. Application-specific requirements can be implemented via individual A and B-side characteristics, adjustable flow regulators, pressure increase and priority functions as well as pressure and speed regulation. The result is a machine that offers consistently intuitive and sensitive operation with the ideal setup.

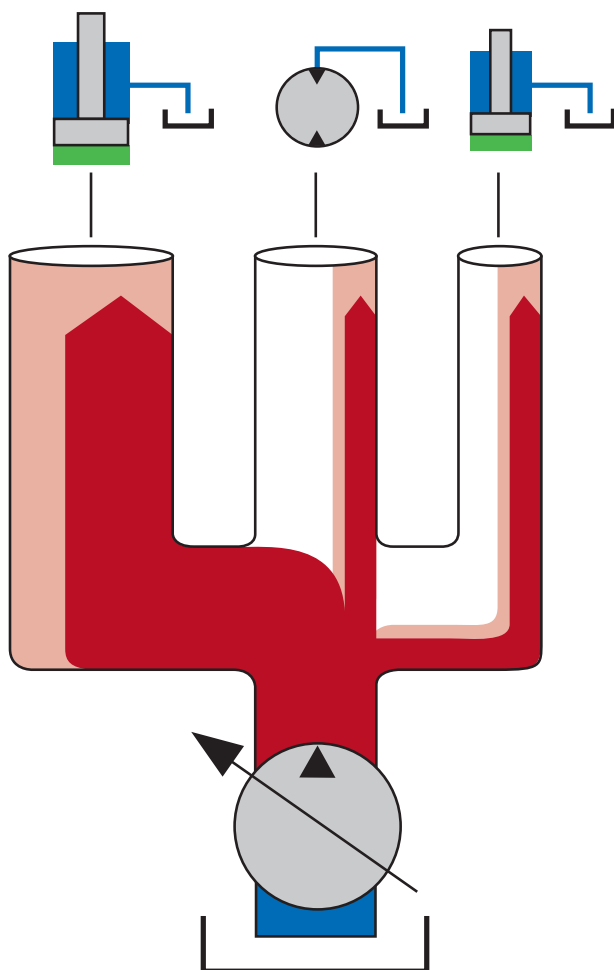

- Demanded flow (150% pump capacity)
- Distributed flow (100% pump capacity)

### Design

- Load-sensing system with downstream pressure compensators (post-compensated LS)
- Parallel architecture (common LS signal for all actuators)
- Directional control valves in closed center design

### Functionality

- Highly dynamic pump controller
- Demand-based supply to actuators
- Simultaneous movements of several actuators, independent of the load
- Proportional oil distribution even at saturation
- Load held in position when movement begins
- Outstanding fine control, no need for readjustment
- Machine movements can be reproduced exactly through precise control of actuators
- Optional additional functions

### Advantages

- Precise and sensitive control
- Simple, intuitive operation
- Optimal movement continuity even for combined movements
- Effortless and efficient work
- Perfect calibration of individual work functions for a customer-specific machine characteristic
- Superior handling performance
- Low fuel consumption
- Excellent energy efficiency

## LSC functionality and directional control valve design.

The directional control valves are the heart of LSC technology. In the neutral position, the connection between the pump channel and the actuator port at the directional control valve is blocked. A trigger signal causes the control spool to move and start to unblock the channel. The connection between the pump and the actuator can only be established once the pressure built up by the pump matches the pressure applied through the actuator on the opposite side. This is ensured by the pressure compensator, which in this phase of the function begin prevents the load from being lowered.

The pressure compensator also ensures that the actuator moves evenly and that it remains unaffected by the movements of other actuators moving at the same time and using different pressure levels. It provides every actuator with its specific power, independent of the current pump pressure level. Linde directional control valves feature a special layout of pressure copier and pressure compensator. They are integrated into the control spool, meaning oil only has to flow through the valve once on the way from the pump to the actuator, and is conveyed via a direct route.

The latest generation of monoblocks combine the benefits of LSC valve technology in a modular system. Maintaining the low-loss layout of the individual sections in the power class up to 600 l/min, the entire valve unit has also been designed for maximum efficiency. Main channels with wide dimensions run through the entire valve unit. They are arranged below the directional control valve sections to ensure optimal flow, and operate them in parallel.

This means that the oil for an actuator with a directional control valve that is further away from the pump connection will not be first conveyed through the other actuators' sections.

This layout is shown in the diagrams on both this page and the following one. It is retained even if the monoblock is extended to include sandwich valves in order to equip complete machines with a main control plate. The nominal sizes for the monoblock sections and sandwich sections for up to 400 l/min (size 25) or 600 l/min (size 30) can be freely combined. In the same way, either the entire valve unit or individual sections of it can be piloted electrohydraulically without using any additional piping. In addition to the regeneration function for each individual section, the pressure limit valves also offer a regeneration function for the entire unit. In an individual section, the outflow current of a particular function side accumulates and is fed into the pressure limit valve in the opposite side. The total return pressure can be increased in the entire valve unit which is beneficial for example during deceleration while traveling. The outflow current for the individual functions is also used to fill other sections using the pressure limit valves. The proportion of the installed pump output that is no longer necessary can then be used at another position.

### Design characteristics

- One downstream pressure compensator on each side
- Compact design achieved by integrating the pressure compensators into the control spool
- Pressure limit valves with anti-cavitation function for each individual section
- Secondary-side high-pressure relief
- Automatic ventilation of directional control valve caps
- Regeneration function in each individual section and entire control plate
- Option to increase pressure using two-stage LS pressure limit valve

### Advantages

- Low-loss individual sections with only single perfusion from the pump to the actuator
- Wide dimensions of main channels and their well-positioned flow layout ensure excellent efficiency throughout the entire unit
- Volume restriction and function start are both side-selective and adjustable
- Optional electric control
- Section sizes and control types can be freely combined

### Cross-section of LSC directional control valve

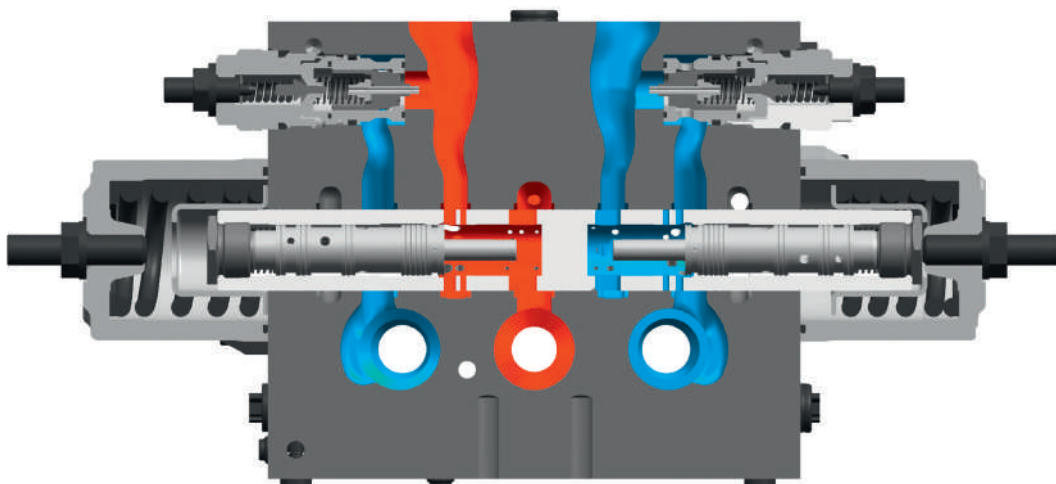

## LSC Monoblocks - Design.

The new monoblock design from Linde features a special layout of the supply channels, i.e. of the pump pressure line and the return channels to the tank. This layout has already been proven to work in the control plates of the VT modular system, and has demonstrated that it results in lower losses. The layout also ensures

that the monoblocks can be fully extended to include sandwich valves even in the same nominal size.

### Conventional monoblock design

- Oil flow circulates in the supply channels around the directional control valve sections
- Shock losses due to circulation
- The greater the distance from the section to pump, the greater the loss in pressure

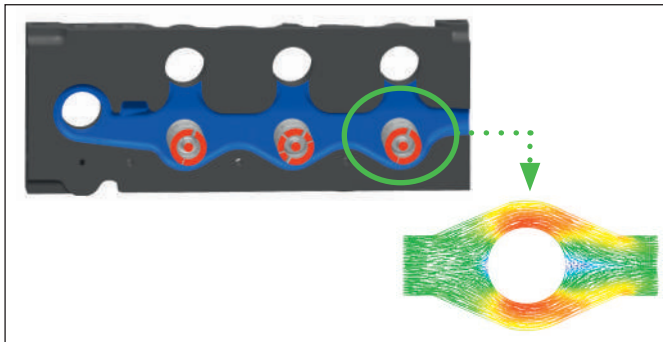

### New Linde monoblock design

- Supply channels positioned below valve sections
- Flow loss reduced by 85%
- Pressure loss virtually identical for all sections, regardless of the distance from the pump connection (measurement: only 1.5 bar from pump inlet via six directional control valves at 600 l/min)

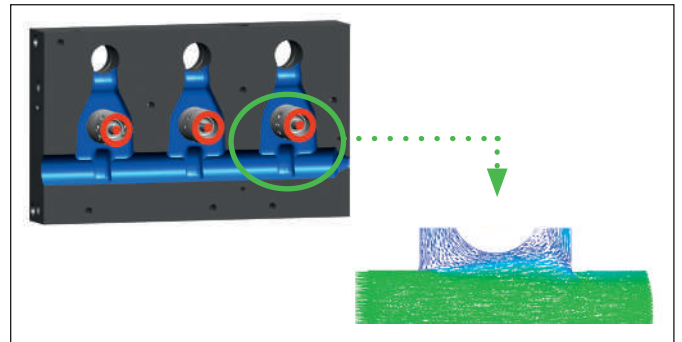

## LSC Monoblocks - Configuration.

### Monoblock design

- Three directional control valve sections of identical nominal sizes in a single die-cast housing
- Nominal size 30, 25 or 18
- Ports for pump, cooler, tank and LS signal
- See overview for extension options

### Monoblock - integrated functions

- Up to six adjustable throttle elements in tank return flow which help to prevent cavitation
- Pressure shut-off, e.g. when clamshell is executing a throwing motion
- Control signal for hydraulic motor
- Regeneration function to save energy

### LSC valve sections

- Downstream pressure compensators for proportional volume flow distribution if supply is insufficient
- High flow rates at high level of energy efficiency
- Integrated secondary relief valves with reload function for all directional control valve sections with optional adjustment (e.g. as floating position) and optional bypass switch (for propel function, to save energy)
- Leakage-free load-holding valves are available for any valve type and any nominal size and can be added at any position

### Sandwich valves

- Valve section to extend the monoblocks' functionality
- Available in the nominal sizes: 30, 25, 18 and 14
- Up to three sandwich valves per side, one behind the other
- Torque control and own primary pressure relief available as option, e.g. for swing drive applications

### Multifunctional sections

- Swing drive with torque control available
- Grapper-rotate section
- Adjustment or control of the maximum pressure in the section

### PRB - pressure relief block

- Primary pressure relief (pump pressure relief), constant or adjustable
- Unload valve for good response characteristics and short reaction times
- With cooler/tank connection, optional make-up constant or proportionally adjustable make-up pressure
- LS release valve
- Regeneration function to save energy

### In development and available soon

- Float function and regeneration

# LSC Monoblocks - Configuration.

## Rated size 30 (at development stage)

<b>Cover</b> VW18S Sandwich Valve Size 18	1 x	0-3 x	<b>PRB</b> Pressure Relief Block	1 x	<b>VW30S</b> Sandwich Valve Size 30	0-3 x	<b>VW30M3</b> Base-Monoblock with 3 Valves Size 30	1 x	<b>VW25S</b> Sandwich Valve Size 25	0-3 x	<b>VW18S</b> Sandwich Valve Size 18	0-3 x	<b>Cover</b>	1 x
--	-----	-------	--	-----	--	-------	--	-----	---	-------	---	-------	--------------	-----

## Rated size 25

<b>Cover</b> VW18S Sandwich Valve Size 18	1 x	0-3 x	<b>PRB</b> Pressure Relief Block	1 x	<b>VW25S</b> Sandwich Valve Size 25	0-3 x	<b>VW25M3</b> Base-Monoblock with 3 Valves Size 25	1 x	<b>VW18S</b> Sandwich Valve Size 18	0-3 x	<b>Cover</b>	1 x
--	-----	-------	---	-----	--	-------	--	-----	---	-------	--------------	-----

## Rated size 18

<b>Cover</b> VW18S Sandwich Valve Size 18	1 x	0-3 x	<b>PRB</b> Pressure Relief Block	1 x	<b>VW18S</b> Sandwich Valve Size 18	0-3 x	<b>VW18M3</b> Base-Monoblock with 3 Valves Size 18	1 x	<b>VW14S</b> Sandwich Valve Size 14	0-3 x	<b>Cover</b>	1 x
--	-----	-------	--	-----	--	-------	--	-----	---	-------	--------------	-----

### Legend

#### Standard modules (required):

Monoblock VWxxM3

Cover

#### Extension modules (optional):

PRB Pressure Relief Block, with or without make-up module for cooler/tank

Sandwich Valve Plate VWxxS

Rated size	Flows		Ports			
	Per section Pump -> actuator	Return flow block	Pump SAE ISO 6162-2	Cooler / tank SAE ISO 6162-1	Actuators SAE ISO 6162-2	Control pressure ISO 6149-1
<b>VW30</b>	600 l/min	1000 l/min	2x 1 1/2" (38 DN)	2x 1 1/2" (38 DN)	1/4" (DN 32)	M14x1,5
<b>VW25</b>	400 l/min	700 l/min	1x 1 1/2" (DN 38)		1" (DN 25)	
			2x 1 1/4" (DN 32)		3/4" (DN 19)	
<b>VW18</b>	250 l/min	450 l/min	1x 1 1/4" (DN 32)	-	1/2" (DN 13)	
<b>VW14S</b>	150 l/min	(250 l/min)	-	-	-	-

### Operational parameters

Rated pressure: 400 bar

(420 bar after clarification)

Minimum requirement for filtration:  
20/18/15 acc. to ISO 4406,  
maximum size of hard particles: 100 µm

## LSC Monoblocks - Electric piloting.

The directional control valves for the monoblocks can be controlled hydraulically or electro-hydraulically with high centering forces. Linde has over 10 years of experience in developing electrohydraulic controls and manufactures around 250,000 pressure reduction valves for directional control valves every year. These pressure reduction valves are characterized by their rapid pressure build-up and high volume flow of control oil, ensuring they offer high control speeds. In turn, the directional control valves provide optimal reaction and response times. They can also be adjusted to ensure the actuator starts to move in the same way every time depending on the joystick deflection. Two control pressure solenoid valves are available for optimal electrohydraulic control of the directional control valves. These solenoid valves are matched to the directional control valves in terms of their output and dimensions.

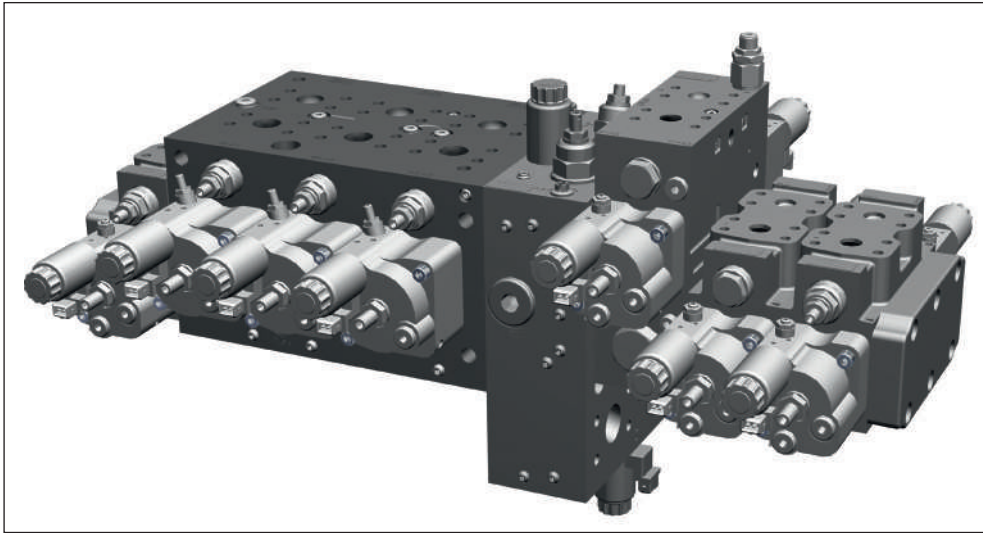

Example configuration with electric piloting based upon a VW25M3

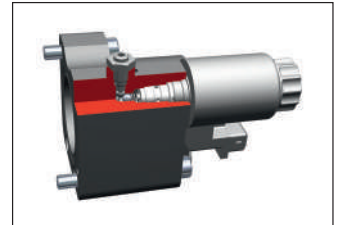

Pressure reducing valve for rated sizes 18 and 14

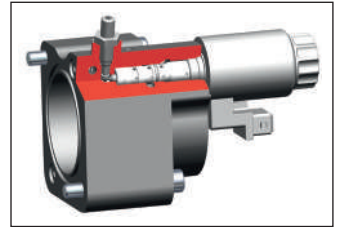

Pressure reducing valve for rated sizes 30 and 25

## LSC+, the adaptive LSC.

With its latest LSC generation, Linde combines the design characteristics of the proven LSC system with the benefits of the electric control. The powerful electronic control unit recognises the operator's command by the amplitude and the speed with which the joysticks are being moved. It then sets the pump and the valves according to the dynamic demand. Due to the overlaid, classic load-sensing control mechanism, no sensors are needed. All components are provided by a single source and matched perfectly with each other. The operator can change the system's behaviour electronically with regard to its dynamics and fine control, as well as its dependency or independency on the load. This enables multi-purpose machines which can quickly be optimized to the specific use by the operator. With completely opened valves, the actuators can be controlled exclusively via the pump's control to achieve the maximum possible efficiency. Existing LSC Systems can also be enhanced with the LSC+ functionality step by step.

### Design characteristics

- Core components of the proven LSC system
- Robust system without sensors
- Electronic joysticks and powerful electronic control unit
- Electric control of pump and valve plate
- Simple control via CAN-interface for the display
- Suitable for single circuit and intelligent multiple circuit systems

### Product advantages

- Direct response behaviour
- Most simple machine operation
- Further increase in energy efficiency
- Automatic recognition of the working condition in high dynamic or fine control mode
- Automatic optimization of typical tasks like grading or shaking the bucket of an excavator
- Manual adjustment of load dependent or load independent system behaviour and system dynamics by the operator
- Optional prioritization of actuators with each other enables an adjustment to the current situation, like e.g. the space curve
- Automatic, jerk-free switching from single to dual circuit mode during motion

**LSC<sup>+</sup>**

## LSC Monoblocks - Configuration examples.

The Linde monoblock concept is designed to match varying machines. The components themselves are basically identical for all types of machines, which reduces the efforts for warehousing and training needs of the service staff. Below there are three applications examples arranged. Our sales engineers will be happy to help you selecting the proper components and tuning your application perfectly.

### Example configuration 24 t wheeled excavator

- Boom / stick / bucket at the monoblock
- Pressure relief block with proportional cooler/tank make-up valve
- Swing drive with priority function and separate primary pressure relief
- Propel drive
- Dozer blade / outrigger
- Hydraulic hammer valve (optional)

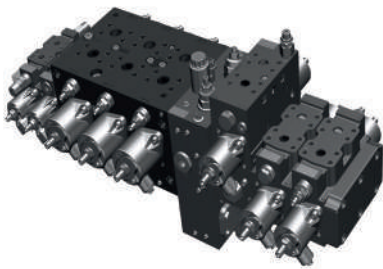

### Example configuration 30 t crawler excavator

- Boom / stick / bucket at the monoblock
- Pressure relief block with proportional cooler/tank make-up valve sandwich swing drive with priority function and primary pressure relief
- Load Sensing-Shut-off
- 1x sandwich propel drive



### Example configuration 24 t crawler crane

- Electro-hydraulic piloting
- Lifting / telescoping / winch at the monoblock
- Pressure relief block
- 2x sandwich propel drive



# How to reach us.

**Post** Linde Hydraulics GmbH & Co. KG  
Wailandtstraße 13  
63741 Aschaffenburg, Germany

**Phone** +49.60 21.150-00 switchboard  
**Fax** +49.60 21.150-11570

**E-Mail** info@linde-hydraulics.com  
**Internet** www.linde-hydraulics.com

## Linde Hydraulics Worldwide.

(ES) Linde Hydraulics Ibérica, S.L.U.  
Camí Can U'bach, 41 A, 08620 Sant Vicenç dels Horts (Barcelona), Phone +34 93 663 32 58, info@linde-hydraulics.com.es

(FR) Linde Hydraulics France SARL  
1, rue du Maréchal de Lattre de Tassigny, 78854 Elancourt, Phone +33 130 684 675, info@linde-hydraulics.com

(GB) Linde Hydraulics Limited  
12-13 Eyston Way, Abingdon Oxfordshire OX14 1TR, Phone +44 1235 522 828, enquiries@lindehydraulics.co.uk

(IT) Linde Hydraulics Italia SpA  
Viale dell'Unione Europea, 33, 21013 Gallarate (VA), Phone +39 0331 182 4910, info.it@linde-hydraulics.com

(USA) Linde Hydraulics Corporation  
5089 Western Reserve Road, Canfield Ohio 44 406, Phone +1 330 533 6801, info@linde-hydraulics.co

(BR) Linde Hydraulics South America  
Av. Leôncio de Magalhães, 1004 cj. 33, 02042-001 São Paulo, Phone +55 11 2281 7879, info.br@linde-hydraulics.co

(CN) Linde Hydraulics (China) Co., Ltd.  
No. 197 Weian Road, High-Tech Development Zone, 261000 Weifang, Phone +86 536 5075293, info@linde-hydraulics.com.cn  
No. 89 Jinshang Road, 361009 Xiamen, Phone +86 592 53 87 701, info@linde-hydraulics.com.cn

Visit [www.linde-hydraulics.com/worldwide](http://www.linde-hydraulics.com/worldwide) to find a dealer close to you.

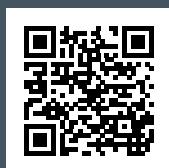

Turning Power into Motion.

